

### Civil Structures

<b>LEVEL:</b>	Grades 9/10 and 11/12
<b>TYPE OF CONTEST:</b>	Team
<b>COMPOSITION OF</b>	2-3 students per team
<b>TEAM: NUMBER OF</b>	Preliminary – As determined by your local MESA Center
<b>STUDENTS:</b>	Regional - 1 for 9/10 Grade; 1 for 11/12 Grade per Center
<b>SPONSOR:</b>	Luis Topete, Director, San Diego State University MSP Jeanette Espino, Director, Imperial Valley MSP

**OVERVIEW:** Students will design and construct a model balsawood bridge from their own plans that will carry a maximum load while using as little wood as possible, stressing neatness, craftsmanship, and creativity. **Participation logistics, limits, and competition facilities may vary by host site. Advisors and students are responsible for verifying this information with their center director.**

The purpose of the Engineering Lab Book is for students to more closely follow the practices of an engineer in the completion of their MESA Day projects. The Engineering Lab Book will encourage students to take a purposeful and sustained approach to building their devices. MESA projects are not designed to be completed in a single class period or day, but to be the result of thoughtful research, planning, analysis and evaluation. The lab book should provide a daily and constant written record of the thought and insight that a team is putting into their project, from initial ideas to the final completed project.

**MATERIALS:**  $\frac{1}{4}$ " x  $\frac{1}{4}$ " square balsawood (ten 3 ft lengths usually sufficient) and water soluble Elmer's-type white glue.

There are three format options for lab book submittals (See Engineering Lab Book Rules). Please check with your local center director for the format required for your preliminary event. Electronic submissions will be required at the Regional/State level.

**GENERAL RULES:**

- 1) Civil Structure should be labeled with team members' names, school, and MESA Center. There will be a 10% penalty in the strength to weight score for failing to properly label.
- 2) No Kits are allowed.
- 3) **Joints must be at or within ¼” of the end of at least one of the sticks (members).** No part of a stick may be glued to another stick except at the joints of sticks. i.e gluing is very limited. See Appendix C, “Clarification of Gluing.”
- 4) No glue may extend beyond 3 mm of any joint.
- 5) The bridge **MUST** meet the following dimension restrictions:
  - a. Maximum length = **40 cm**
  - b. Maximum width = **10 cm**
  - c. Maximum height = **21 cm**
  - d. Minimum clearance = **10 cm**
  - e. Minimum span = **25 cm**
  - f. Maximum Bridge Weight = **95 grams**
- 6) Members joined at an angle must be at an angle of 30 degrees or more.
- 7) Members may be carved, notched, or cut anywhere along their length.
- 8) Pins and/or gussets are not allowed.
- 9) No material (e.g. paint, varnish, hairspray, etc.) may be applied to the bridge. Ink or pencil to identify bridge builders, school, and center is ok.
- 10) **Maximum allowable weight of completed structure is 95 grams.**
- 11) Top of bridge must support a 10 cm x 10 cm plate which will bear the load for testing.
- 12) Bridge must have supports at least 25 cm apart and must measure at least 10 cm above a flat surface (an imaginary “river”) at at least one point (may be more than one point) between the supports.
- 13) Project must be the original work of student(s). Judges may ask questions to confirm provenance.
- 14) Please remember that the purpose of this contest is to use creativity to build the best structure within the framework of the rules. The purpose is not to break the rules and see if you can get away with it.

**JUDGING:**

- 1) Prior to load testing, the bridge receives a specifications check to determine whether it conforms to the weight, dimension, and construction rules.
- 2) Bridge is weighed and its weight recorded.
- 3) Bridges are judged for neatness, craftsmanship, and creativity by a team selected by Host Center prior to testing.
- 4) Bridge will be tested for load bearing capacity using the set-up shown in Testing Setup & Apparatus. The maximum load recorded by the load testing machine will be used as the load capacity of the bridge, regardless of when failure begins.
- 5) Disqualified bridges are not eligible for awards in any category. However, they may be tested in private, time permitting.

- 6) Strength-to-Weight Ratio: Determined by dividing maximum load at failure by weight of bridge. Bridge with greatest load bearing capacity compared to its weight wins.

Example:                   Maximum load = 120.0 pounds  
                                  Bridge weight = 20.0 grams  
                                  Ratio =  $2724.0 * [120 \text{ pounds} \times 454\text{g/pound}] / 20\text{g}$

- 7) Creativity & Engineering Design: Finest workmanship, including neatness and innovation of design.

**AWARDS:**

- Awards will be given per grade level: 9<sup>th</sup>/10<sup>th</sup> grade and 11<sup>th</sup>/12<sup>th</sup> grade.
- Medals will be awarded for 1<sup>st</sup>, 2<sup>nd</sup>, and 3<sup>rd</sup> place based on the best Strength-to-Weight Ratio
- Ribbons will be awarded for Creativity and Engineering Design.
- Only teams placing 1<sup>st</sup> place in the Strength-to-Weight category (from each grade level) will advance to Regional MESA Day.

**ATTACHMENTS/APPENDIX:**

- A - Sample Joints
- B - Testing Setup & Apparatus
- C - Clarification of Gluing
- D - Specification Checklist

**A – Sample Joints**

**GENERAL RULES #3:**

Joints within the 1/4" of the end of at least one of the sticks (members).

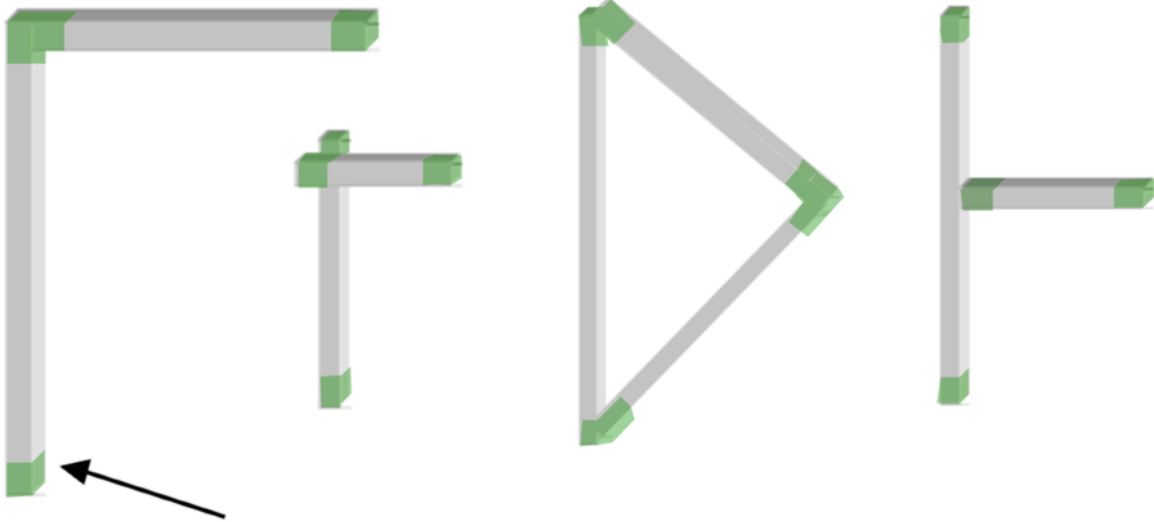

Areas in green are the cleared areas for joints within the 1/4" - figure not shown to scale.



Following joints are not within the 1/4" of the end of at least one of the sticks (members).

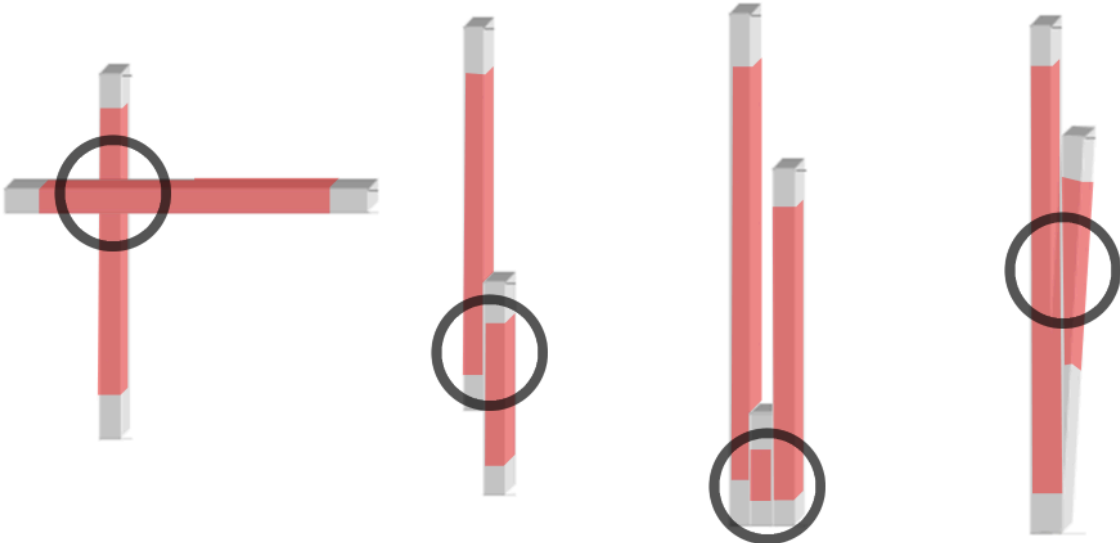

**B – Testing Setup & Apparatus**

- 1) Figure 1a: Overall Dimension Test: The bridge must fit inside a box with the following dimensions to be considered legal; bridge must also pass the 10 cm clearance test.

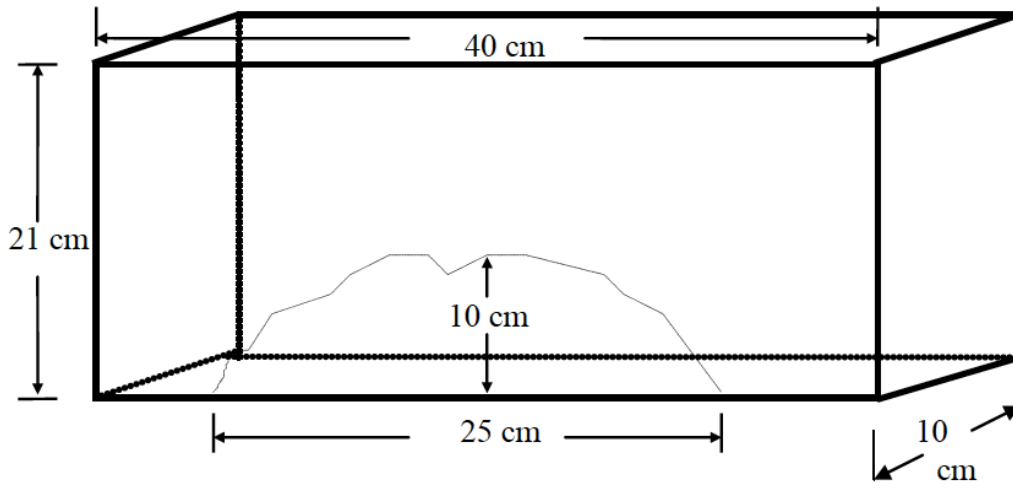

The bridge must clear the 10 cm line at at least one point (above an “imaginary river”) in the 25 cm span.

- 2) Figure 1b: The bridge will be supported on both of the blocks as shown:

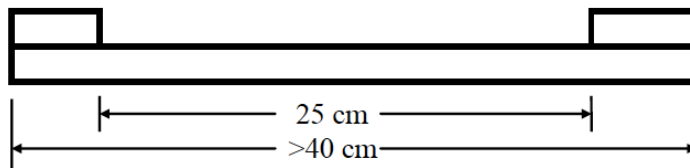

- 3) Figure 1c: Span clarification between bridge supports.

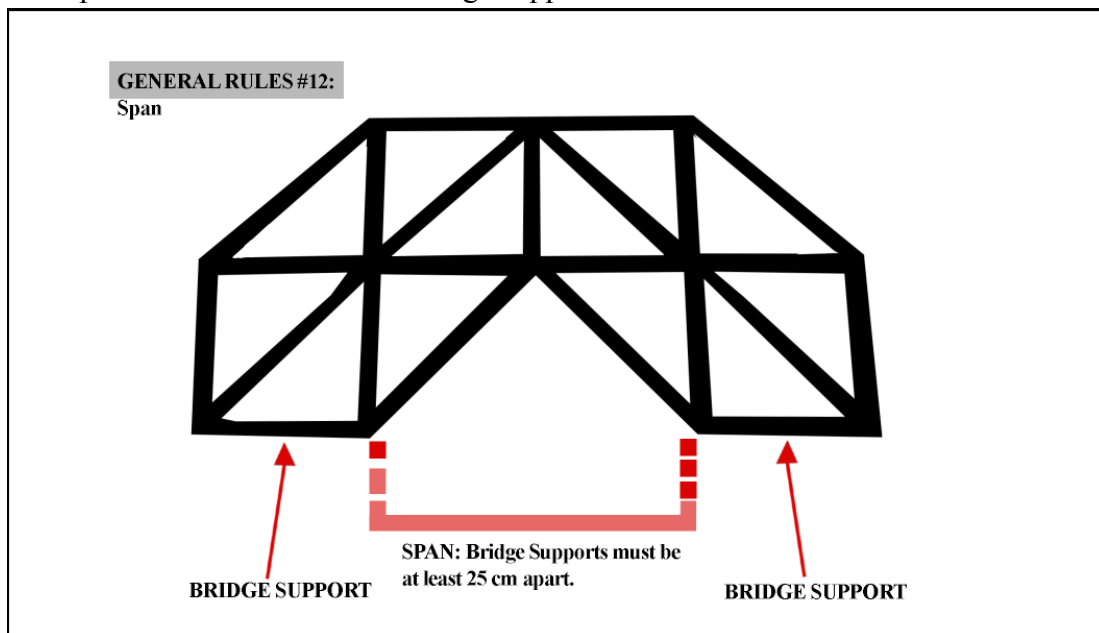

4) Figure 1d: Imaginary River and clearing the 10 cm line.

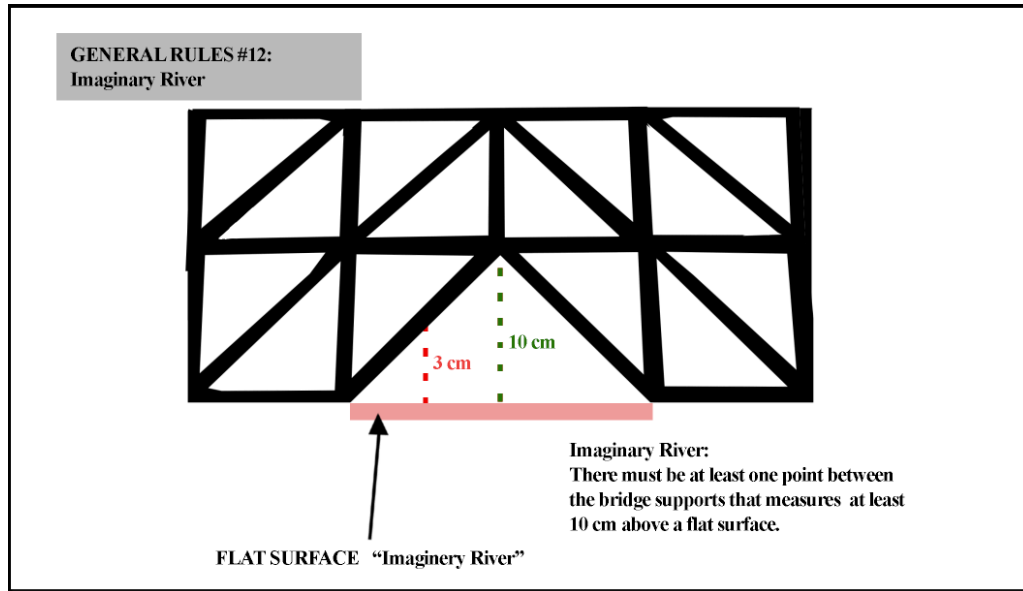

5) Figure 2: The bridge is tested for strength by applying weight (force) to a 10 cm square plate placed on top of the bridge. The bridge is tested for strength while sitting on the blocks. Additionally, note dimension details in the figure below.

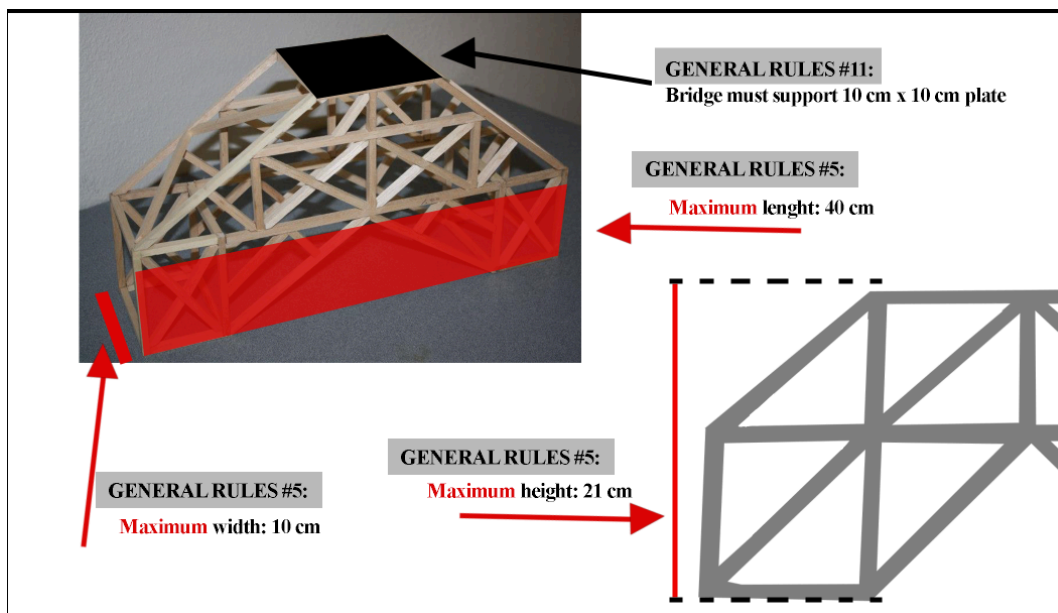

6) Figure 3: Members joined at an angle must be at an angle of 30 degrees or more.

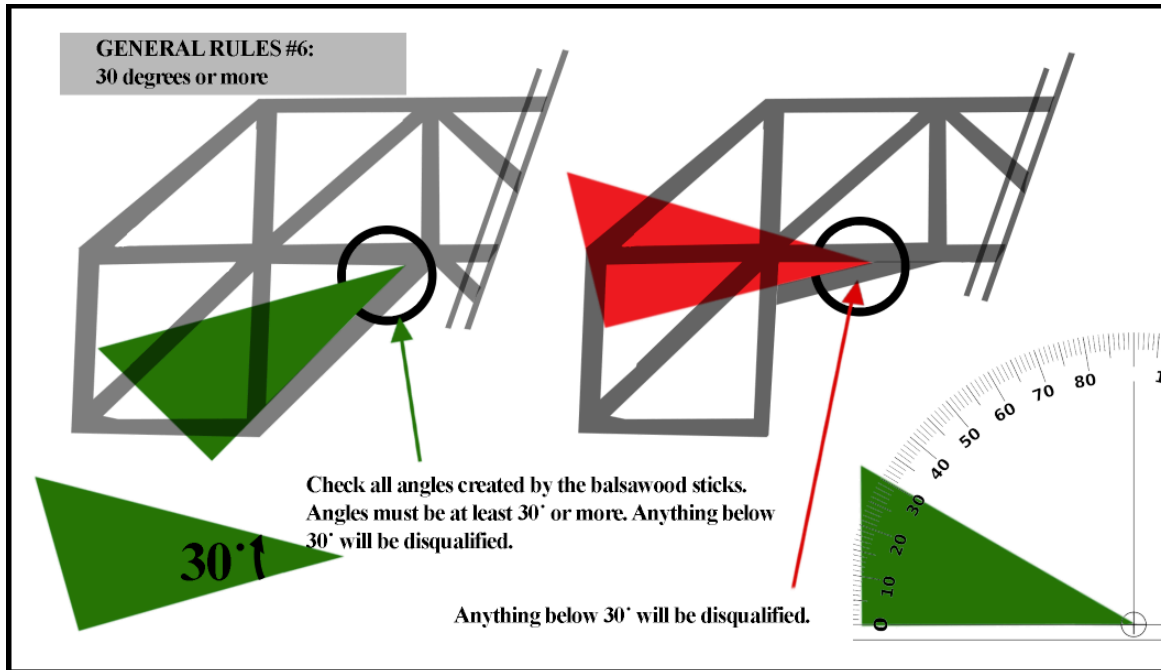

### C – Clarification of Gluing

- The spirit of the gluing rule is to allow bridges made of balsa **ONE LAYER** thick. Since the balsa may need to be overlapped at the joints, the bridge may need to be more than one layer thick at the joints.
- Rule for Construction #1 states: “**Joints must be at or within ¼” of the end of at least one of the sticks (members).** No part of a stick may be glued to another stick except at the joints of sticks. (i.e., gluing is very limited). (See **ATTACHMENTS/APPENDIX – Sample Joints**)
- Since dry glue is nearly invisible and it is impossible to tell what part of overlapping members is glued and what part is not, judges must assume that the entire length of overlapping members is glued. Therefore, no two members anywhere on the bridge may overlap by more than ¼”.
- ¼” long pieces of balsa may be used as “spacers.” A spacer is defined as a piece whose sole role is to separate structural members (such as at the corners of the bridge).
- Wholly glued pieces which appear to strengthen, reinforce, serve a purpose other than separating, or are placed too closely together will be considered lamination, not spacers.
- Determination of what is a spacer and what is excessive gluing will be left solely to the judges. Since this may be a “gray area,” with disqualification as a possible result, students are encouraged to avoid the use of spacers.
- Please remember that the purpose of this contest is to use creativity to build the best structure within the framework of the rules. The purpose is not to break the rules and see if you can get away with it.

### **D – Specification Checklist**

*\*Note: As the name above implies, this list is intended simply as a guide for meeting the required competition specs. It should not be treated as an official judging document.*

- Bridge is properly labeled with team members names, school, and MESA Center
- Material is ¼” x ¼” balsawood
- Glue is water soluble Elmer’s-type white glue
- Maximum length  $\leq 40$  cm
- Maximum width  $\leq 10$  cm
- Maximum height  $\leq 21$  cm
- Minimum clearance above “river”  $\geq 10$  cm
- Minimum Span  $\geq 25$  cm
- Maximum Bridge weight  $\leq 95$  grams
- All joints are at or within ¼” of end of one member
- No glue beyond 3mm from any joint
- No excessive gluing (i.e. members are glued only at the joints)
- All members joined at an angle  $\geq 30^\circ$
- No pins or gussets used
- Balsawood is not painted or treated
- Top center of Bridge has 10 cm x 10 cm area for placement of the test plate
- Bridge has supports suitable for placement on testing fixture